

# Segway CMBalance Robot Soccer Player

Jeremy Searock, Brett Browning, Manuela Veloso

May 2004

CMU-CS-04-143

School of Computer Science  
Carnegie Mellon University  
Pittsburgh, PA, 15213

This research was sponsored by the United States Army under Grant No. DABT63-99-1-0013. The views and conclusions contained in this document are those of the authors and should not be interpreted as necessarily representing official policies or endorsements, either expressed or implied, of DARPA, the US Army, or the US Government.

**Keywords:** games, mobile manipulation, mobile robots

## **Abstract**

The Segway™ LLC company has provided a robust mobility platform on which to research human/robot coordination in an adversarial environment. The Segway Human Transport (HT) is a one person dynamically self-balancing transportation vehicle. The Segway Robot Mobility Platform (RMP) is a modification of the Human Transporter capable of being programmed for autonomous operation. With these platforms, human/robot coordination is being investigated through the competitive game, Segway Soccer. The game is played between robots (RMPs) and humans (riding HTs), who can be teammates or opponents. The rules of the game are a combination of soccer and ultimate Frisbee rules. This paper describes the design of the mechanical systems necessary to allow the Segway RMP to safely and effectively play a competitive game of Segway Soccer along with humans. Specifically, the challenge of designing a soccer ball manipulation/kicking system is described in depth.

## 1 Introduction

Considerable research has been conducted involving human-robot interaction [8], and multi-agent teams [9, 10, 11]. With the inception of RoboCup robot soccer [7], multi-agent team coordination within an adversarial environment has been studied extensively. But, the dual topic of human-robot coordination in an adversarial environment has not been investigated. This research involves the intelligent coordination of mixed teams of humans and robots competing in adversarial tasks against one another. The results of this research will further the technology necessary to allow both humans and robots to productively work together in complex environments requiring real time responses.

In order to further investigate human-robot interaction in team tasks, we have developed a new game called Segway Soccer. The teams can consist of two humans, two robots, or a mixed human/robot team. The rules of the game are very similar to soccer with a slight influence from the game of ultimate Frisbee. A goal is scored by kicking a regular size 5 soccer ball into a goal which is 2.5 meters wide. One key contribution from ultimate Frisbee is that once a player is declared to have possession of the ball by a referee, the player cannot dribble. The player has a one meter radius in which to reposition and pass to a teammate. Additionally, an opponent is not allowed to contest the player with possession by entering the radius. Another similarity to ultimate Frisbee is that one team or the other will have possession of the ball at all times. Robots and humans will not be running towards each other to gain possession.

To ensure robots and humans will collectively be involved, a mixed team cannot officially score unless both a robot and a human interact with the ball on the way to the goal. Since robotic technology is not yet able to match the physical abilities of humans, a mobility platform is necessary in order to equip both robot and human players with the same physical capabilities. This has been accomplished by Segway LCC in the form of the Segway™ Human Transporter (HT) and the Segway™ Robot Mobility Platform (RMP).

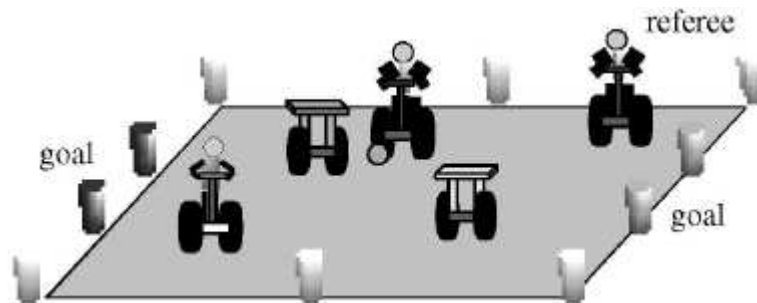
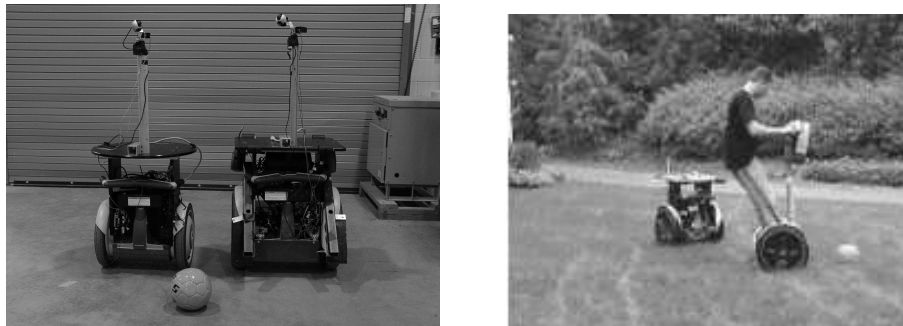

Figure 1 Soccer field for a 2 on 2 mixed team game

### 1.1 The Segway HT and RMP

The Segway™, developed by Dean Kamen, is a two-wheeled dynamically balanced mobility platform. The Segway has onboard sensors and computer controllers that continually and independently send controls to each wheel in order to maintain the center of mass balanced under its wheels. The human rider controls the velocity of the Segway by leaning forward, shifting the center of mass, and causing the Segway to drive forward in order to rebalance. The rider can stop or slow down by leaning backwards. Riding skills are quickly learned by an inexperienced player. Human Segway Soccer players operate a HT while the Segway RMP is the robot platform.

The RMP provides a robust robotic agent on which to create human-scale robot soccer players. The Segway RMP consists of a Segway HT ‘roboticized’ by Segway LLC. The RMP consists of three main modifications to the HT. First, a CAN Bus interface is exposed to enable two way, high speed electronic communication with the platform. Second, the Segway’s control software is modified to enable a computer to send direct velocity commands to the platform. The third change involves attaching a large mass of about 23 kg at a height of 50 centimeters from the robot wheel base. This serves the purpose of raising the robot’s center of gravity which slows down the RMP’s falling rate in order to allow the Segway’s control loop to operate effectively. With this basic infrastructure, two laptop computers are used. One laptop is used to provide the RMP with the capability to interpret the world with data from a CCD camera and another laptop to quickly decide what action to take and to send commands to control the actions of the RMP. The Segway HT and RMP are great mobility platforms to place humans and robots on an equal physical level, but many modifications and additions are necessary to make these platforms capable of playing Segway Soccer.



**Figure 2 Segway RMPs and a Human on a Segway HT**

## **2 Turning a Segway into a Soccer Robot**

This new domain of human-robot interaction raises the requirements of robot mechanical systems to a more sophisticated level. The challenge becomes designing adequate hardware that will allow a robot to safely and robustly operate in an outdoor environment along with humans in a competitive soccer game.

In meeting this challenge, we have developed 4 key goals. First, the soccer player must be autonomous by perceiving the world, making decisions, and acting without human intervention. Second, the player must be able to interact with human players by recognizing their presence and communicating. Third, the player must be able to manipulate a ball well enough to be competitive with humans. Lastly, safety must be considered in every aspect to prevent injury to humans and damage to equipment.

With these goals in mind, we have to consider the many challenges that accompany designing and implementing a complete robotic system. Cost effectiveness, processing power, perception, weight distribution, and resistance to shock are all important considerations. The unique motion of the Segway also introduces problems not seen with other platforms.

The Segway moves forward by tilting forward and driving the wheels in order to rebalance. This motion can lead to the ball becoming stuck underneath the body and wheels of the Segway. This causes the wheels to lose contact or traction with the ground making the Segway unable to sufficiently maintain balance. Any consequential fall could potentially damage equipment. As a

solution, guards, consisting of modified rubber mud flaps, were placed in front of the wheels to push the ball away and computer control software was implemented to prevent the RMP from interacting with the ball unless it knows the manipulation system can safely kick.

Another challenge introduced with Segway Soccer is that there is no unique playing surface; it can be played on grass, Astroturf, or cement. Changes in grass height, ground softness, and surface texture alter the dynamics necessary to manipulate the ball. Unlike other robotic soccer platforms, the Segway also tips up to +/- 20 degrees with respect to the vertical; thus, any attached kicking plate and system will also tip. This requires the manipulation system to be robust enough to manipulate the ball under changing conditions.

The Segway RMP player must possess the capability of consistently recognizing field markers, players, opponents, and the ball. Since the ball and the opponents are continuously moving and the USB camera only has a 42 degree horizontal and a 32 degree vertical field of view, a pan tilt servo system mounted at near human eye level is necessary to ensure a complete and robust world observation can be made. The RMP is non-holonomic; therefore, in order to receive a pass, it must look sideways to track the ball as it drives forward or backward to stop the ball with the side of its wheel. This camera mobility allows the robot to drive in one direction while it updates the world model by looking in another.

A *PONTECH* microcontroller was added along with a custom PCB to control the pan/tilt servo motors, to control the solenoid valves to activate the pneumatic kicking system, to monitor the tank pressure, and to activate the onboard air compressor. This board can communicate with the laptops through the serial port.

The RMP must also possess the capability of communicating with a human player. A soccer game requires both humans and robots to quickly communicate with each other in order to effectively position themselves to score a goal. This communication is unique in that in addition to human players being able to tell a robot where to go, a robot can tell a human player where to reposition. Presently, speakers mounted on the RMP allow the robot to communicate with the human players.

A 12V power supply separate from the RMP drive power was added to power the control board, speakers, and other components. We used a 12V sealed lead acid. The Segway battery, lead acid battery, and both laptop batteries can also be charged with one power-strip that can be plugged into a wall outlet. This setup ensures all components will be properly charged.

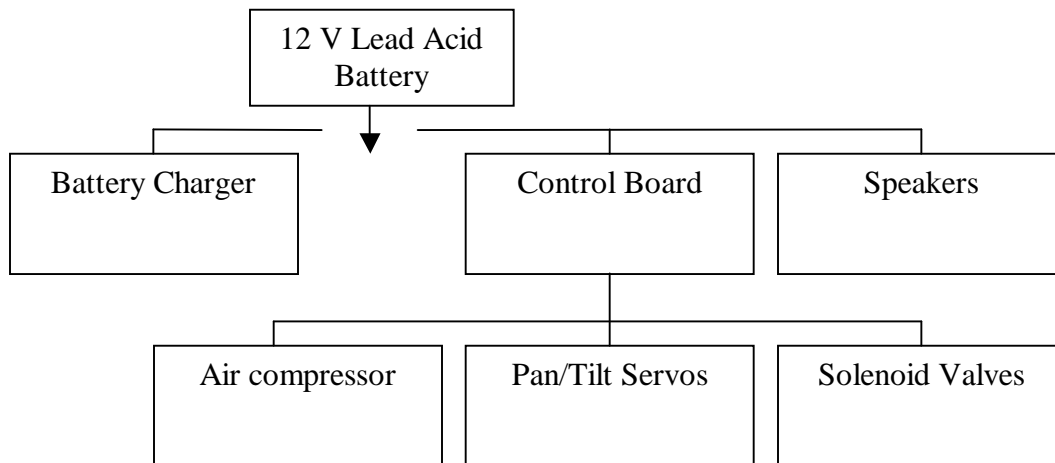

**Figure 3. 12V Power Supply Schematic**

Finally, hardware must be able to protect the components of the Segway from damage during a fall. The laptop computers and ball manipulation system components are mounted as close as possible to the bottom of the Segway reducing their falling distance and the shock they will absorb. The laptops are also securely fastened with Velcro straps preventing them from being ejected from the confines of the RMP body. The laptop mounting is attached using two of the three mounting screws on the inside of the wheel housing. Angle bracket can be added to these screws in order to support a length of sheet aluminum. The goal in the laptop mounting is to allow easy access while preventing damage.

Steel safety stands were also added to reduce the total distance the Segway will fall once it is no longer capable of dynamically balancing. In a soccer game, the RMP always has the potential of falling over due to high speeds, uneven terrain, and interaction with the ball or other players. The stands mount onto the side plates of the RMP and only allow it to fall over 30 degrees from the vertical. The key in designing safety stands is to keep the stands as compact as possible. Since the RMP is capable of a zero turning radius and can spin fairly fast, protruding stands are a potential safety hazard. If the stands are too compact, a high speed fall could cause the RMP to fall over top of the stands.

The main challenge was designing a ball manipulation system that allows a Segway platform to kick a ball to the scale of an outdoor human game. The design is necessary for Segway Soccer to be possible since scoring can only take place by passing the ball to teammates. We present the information necessary to design and implement a ball manipulation system for a Segway platform and similar mobile robots.

### 3 Kicking System Design Considerations

A ball manipulation system can be described as a mechanical manipulator used to accelerate a ball to a desired velocity in a desired trajectory. This can be achieved in many different ways with various actuators. The most common systems come from the realm of robot soccer as seen in RoboCup [7] competitions. These include pneumatic, spring, solenoid, rack and pinion, and rotating plate systems. A careful analysis of the following factors is needed to determine which kicking system best fits a given platform and environment:

<b>Speed</b>	<b>Accuracy</b>	<b>Kick Capacity</b>
<b>Response Time</b>	<b>Recovery Time</b>	<b>Safety</b>
<b>Complexity</b>	<b>Weight</b>	<b>Size</b>
<b>Power</b>	<b>Reliability</b>	<b>Maintenanc</b>

**Figure 4. Kicking System Design Considerations**

With these considerations in mind, the actuating system must be chosen. For each option, we present the basic system components, the mathematical models necessary to properly specify an appropriate actuator, and an example comparing each option to the pneumatic system we implemented and describe in section (4).

#### 3.1 Spring Loaded Mechanisms

Spring kicking mechanisms use an extension or compression spring(s) to store and then release energy to propel the ball. As such, a mechanism is needed to tension the spring(s) and a trigger to release the stored energy. Such mechanisms must be robust, and are non-trivial to design. Apart

from the obvious complexity, spring strength is coupled to kicking power, but a more powerful spring is more difficult to retract and hold. This relationship leads to potential problems during a soccer game where the time to reload a powerful spring can take several seconds if a cheaper less powerful motor is used. Springs do provide the best power density out of the given the options [4, 5].

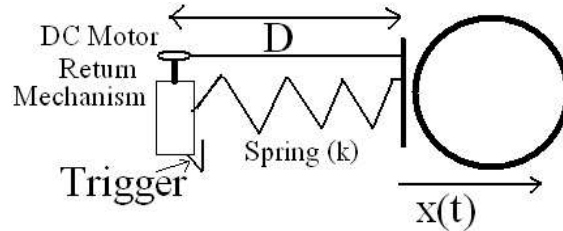

**Figure 5. Spring Kicking Mechanism Schematic**

For a spring with a spring constant of  $k$ , a kick length of  $D$ , and a kicking mass of  $m$ , the force equation and resulting equations of motion for the spring mechanism are:

$$\ddot{x} = -kx \cdot m^{-1} \quad x(0) = D \quad \dot{x}(0) = 0. \quad (1)$$

$$x(t) = D \cos\left(\sqrt{\frac{k}{m}}t\right). \quad (2)$$

For the Segway, the pneumatic kicking system model predicts the ball will be kicked at a 4.3 m/s max velocity. Using the above equations, one can determine the spring constant,  $k$ , necessary to achieve a similar speed with a similar stroke length to the pneumatic model (0.1524m). Assuming a kicking mass of 0.85kg, a spring constant of 676 N/m would be necessary. This would require a force of at least 103N in order to load and hold the spring at 0.1524m for a kick. Depending on motor size and consequentially cost, the spring would take one to several seconds to reload for another kick. Complexity, reload time, and cost are the limiting factors for the spring kicker design.

### 3.2 Rotating Plate Mechanisms

Rotating plate kickers consist of two or more flat surfaces, bars, or other contacts arranged in a balanced paddle boat configuration. [1] The shaft of the paddle wheel is connected to a DC motor. The angular velocity of the paddle wheel determines the end velocity of the ball, although there is great variability due to the potential variation in the contact point. Pulse Width Modulation can be used to vary the speed of the wheel and thus vary the power of the kick. Rotating plate mechanisms require a significant amount of space to mount the paddle wheel and the drive motor. Furthermore, for larger robots, rotating plates become extremely dangerous to human operators. A rotating plate mechanism scaled to the size of a Segway would have to be approximately 18cm by 38cm. The plates would be rotating fast enough and with enough power to cause injury to humans who happen to fall off of their HT into a kicking device. As a result, we do not consider a rotating plate mechanism in depth.

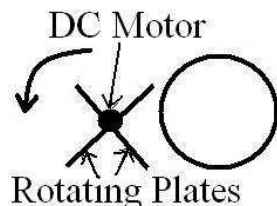
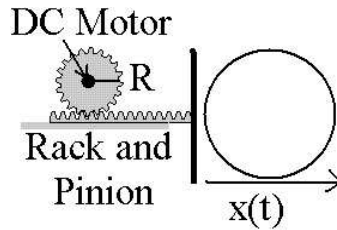



**Figure 6. Rotating Plate Kicker Schematic and Physical Example**

### 3.3 Rack and Pinion Systems

Rack and pinion systems are driven by DC motors and thus the ball velocity is dependent on the output power of the motor. For a rack and pinion motor system with a back emf of  $k_e$ , voltage of  $V$ , forward torque per amp of  $K$ , terminal resistance of  $R$ , pinion radius of  $r$ , gear ratio of  $N$ , and total kicking components mass of  $m$ , the following are the equations of motion:



**Figure 7. Rack and Pinion Kicking System Schematic**

$$\ddot{x} = \frac{K}{mr^2R} (Vr - k_e \dot{x}) \quad x(0) = 0 \quad \dot{x}(0) = 0 \quad (3)$$

$$x(t) = \frac{Vr}{k_e} t - \frac{mr^3RV}{NKk_e^2} \left( 1 - e^{-\frac{k_eKN}{mr^2R}t} \right) \quad (4)$$

A rack and pinion system with a powerful motor is comparable to the other options but the price and design requirements are more significant. Using an 80W Maxon motor [12], a 0.015m pinion radius, 1:1 gear ratio, and a total kicking mass of 1.3 kg, the rack and pinion system can accelerate the ball to a theoretical velocity of 6.7 m/s in 0.1524 m (6in). With a motor efficiency around 75% and the friction forces acting against the sliding rack, the actual velocity will be closer to 3.5 m/s.

The Segway does not have enough space to implement a single rack and pinion system. Two rack and pinions would be needed since one rack and pinion could not be placed in the middle of the Segway due to the handle bar mounting. This would require two motors or a much larger single motor to actuate both rack and pinions. This requirement makes this system unfeasible for use on a Segway platform. The two high power motors would also be costly [3].

### 3.4 Solenoid Systems

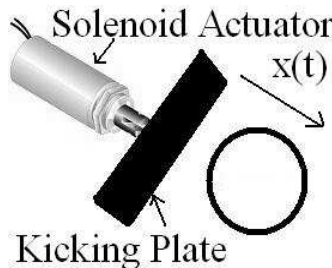

**Figure 8. Solenoid Kicker Schematic**

A solenoid kicker consists of a solenoid that creates a magnetic field around a shaft that is propelled by the field and accelerated away from the solenoid. The shaft is returned by a built in return spring. Consider a solenoid kicking system with a current of  $I$ , ampere turns of  $N$ , plunger radius of  $r$ , a return spring constant of  $k$ , and a total kicking mass of  $m$ . The differential equation of motion is given in equation (5). Since this equation can only be solved by numerical means, we approximate the result here for analysis purposes by treating the solenoid force as being constant for the duration. The results are given by equations (6) and (7).

$$\ddot{x} = m^{-1} \left( \frac{1}{2} \mu_0 \pi \left( \frac{rNI}{x} \right)^2 - kx \right), \quad x(0) = 0 \quad \dot{x}(0) = 0. \quad (5)$$

$$\ddot{x} = m^{-1} \left( F_{\text{avg}} - kx \right), \quad x(0) = 0 \quad \dot{x}(0) = 0. \quad (6)$$

$$x(t) = \frac{F_{\text{avg}}}{k} \left( 1 - \cos \left( \sqrt{\frac{k}{m}} t \right) \right). \quad (7)$$

Most commonly available solenoids produce approximately 400N of force and generally have small stroke lengths on the order of 0.0254m (1in), which limit its ability to effectively contact a ball. For the solenoid shown in figure (8) [13], assuming a return spring constant  $k$  of 99 N/m, and a kicking mass of 1.5 kg, a ball would be kicked at 4.1 m/s over 0.0508m stroke length (2in). With the effects of friction and motor efficiency the actual speed would be closer to 3 m/s. This is comparable to the pneumatic system but the smaller stroke length limits its ability to effectively manipulate a ball during a game. The high voltage requirement also raises safety issues.

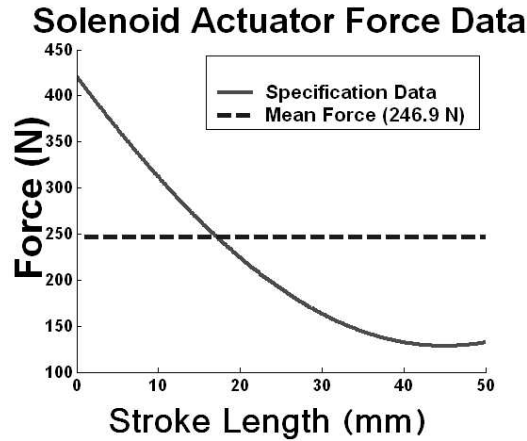
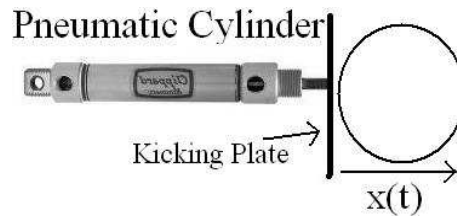

Figure 9. Solenoid Force v. Stroke and Approximate Force

### 3.5 Pneumatic Systems

Pneumatic piston systems usually consist of one or two actuating cylinders, an air reservoir, solenoid valves to control the air flow, a source of compressed gas in the form of compressed air or liquid carbon dioxide ( $CO_2$ ), and a regulator to maintain a specified pressure. The decision between  $CO_2$  and compressed air depends on the availability of  $CO_2$ . Air compressors normally only operate up to 150 psi while  $CO_2$  tanks fill to several thousand psi. This higher pressure allows the cylinders to be fired with a higher output force resulting in a stronger kick. The higher pressure also significantly increases the kick capacity of the system. The major drawback of  $CO_2$  is that it is not easily transportable or available in foreign locations. Additionally, its rapid expansion

during each kick results in thermal issues such as the formation of condensation near electronic parts. As a result, a compressed air approach is often used instead.



**Figure 10. Pneumatic Kicker Schematic**

The pneumatic cylinder pistons connect to a kicking plate that contacts the ball. The plate can vary in material and shape dependent upon application. The one or more pistons can be fired at the same time or in a synchronized order to achieve a directional kick. A pneumatic system offers a wide range of options in its configuration and employment. For a pneumatic system with power factor,  $f$ , combined kicking mass,  $m$ , return spring constant,  $k$ , and operating at a pressure,  $P$ , the equations of motion are:

$$\ddot{x} = m^{-1}(fP - kx), \quad x(0) = 0 \quad \dot{x}(0) = 0 \quad (8)$$

$$\ddot{x}(t) = fP \cdot k^{-1} \left( 1 - \cos\left(\sqrt{\frac{k}{m}}t\right) \right) \quad (9)$$

For a Segway, a suitable cylinder would be approximately 0.254m (10in) long, 0.01905m in diameter and produce 274N for force at 140 psi. The pistons are the only moving parts and the air tank consumes the most space. The price of a pneumatic system is also fairly cheap. A functional system can be bought for less than \$150. The air used to power the cylinders is naturally accessible and can be refilled quickly during a soccer game with an onboard air compressor. The system has a low chance of malfunctioning and becoming inoperable during a game because the only moving parts are the cylinder shafts. [2, 8]

Other factors can be considered when choosing a cylinder. Various versions of single acting and dual acting cylinders offer different advantages and disadvantages. Single acting cylinders require less design work. They normally have return springs that return the piston after it has fired. Spring forces vary with manufacturer and size. Springs have a significant impact on the acceleration of the piston because the spring force acts against the force of the cylinder. The advantage of a single acting cylinder with a return spring lies in its simplicity. It has a built in return mechanism eliminating the design requirement to implement one. A return mechanism is used to reset the position of the cylinder shaft and kicking plate back to their original positions before the kick occurred. At the convenience of the manufacturer, modifications can be made to the design of single acting cylinders to weaken the return spring. For a price, manufacturers are sometimes willing to reduce the strength or the number of springs within certain size and stroke length cylinders to decrease resistant forces and increase piston acceleration. Doing so would decrease the effective force acting against the imparting force of the cylinders and increasing the ability to transmit impulse.

Another cylinder option lies in a dual acting cylinder, which is free of a return spring. Dual acting cylinders contain two input ports, one in the front and one in the rear. The ports allow you to accelerate the piston both out of and into the cylinder body. These versions offer the greatest flexibility. A regulator can be used to place a small pressure into the front input port. This acts as

a pneumatic spring return. The pressure placed on this front port determines the force of the return spring. As a result, the appropriate force necessary to return the piston and the attached kicking plate to their original position can be determined by experimentation. Although the pneumatic spring will resist the acceleration of the piston, the resistance will be the minimum necessary.

If the front port is left open, similar to a single acting cylinder, the piston will accelerate without external resistance. Since the kicking plate and piston need to be returned to their original positions, some mechanical return device needs to be designed and used. Rubber bands or another elastic material can be used. Again, through experimentation, the minimum resistance force necessary can be found, leading to the optimal kicking device.

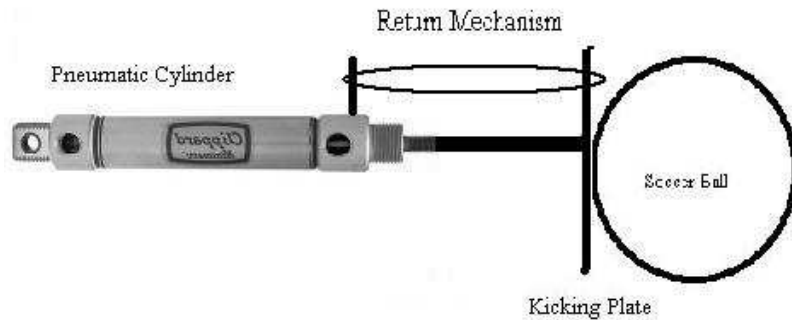
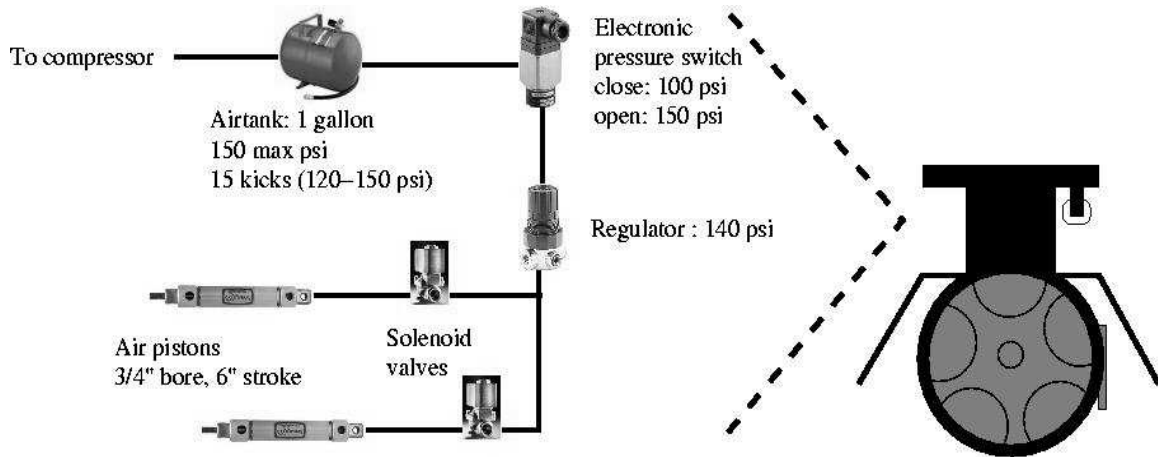

**Figure 11. Example of an elastic return mechanism**

The stroke length of the cylinder shaft can also be chosen to maximize impulse transfer. Theoretically, the longer the stroke length, the better the impulse transfer will result. Since impulse is the integral over time, having the contact plate contacting the ball for a longer time period will increase the impulse. Furthermore, the overall system will have a farther reach in which to contact an object. Longer stroke lengths also introduce other limiting problems. The longer shaft causes the cylinder to be longer, which linearly increases the volume of the cylinder. Therefore, more air volume is required to fire the cylinder. This increases the need for a larger air reservoir to maintain an adequate number of kicks per tank fill-up. Longer stroke lengths are also more susceptible to becoming bent in normal soccer play.

#### **4 Implementation and Results**

With the considerations presented, we chose to use a pneumatic approach due to its relative simplicity, low cost, and transportability. Figure (11) shows the resulting arrangement



**Figure 12. Schematic diagram of the implemented CM-RMP pneumatic kicking system**

- (2)  $\frac{3}{4}$  inch bore dual acting cylinders with 6 inch (0.1524m) stroke length
- (1) gallon air tank (150 psi)
- (2) Solenoid valves
- (1) Regulator
- (1) Serial port firing circuit
- (2) Rubber band return mechanism
- (1) Kicking plate
- 1/8 inch ID tubing related to 10-32 connectors
- (1) Electrical pressure switch
- (1) Onboard air compressor

Two 0.01905m bore, dual acting pneumatic cylinders were chosen as the main actuating components. This size cylinder provides adequate power with a sturdy shaft that can sustain unexpected stress. Dual acting cylinders do not have a return spring to reset the cylinder shafts back to their original position. This allowed us to implement a return mechanism with just enough force to reset the kicking plate without significantly affecting the output force. We used 4 x No.64 (3.5in x 1/4in) rubber bands to return the kicking plate. Two cylinders also allow for directional kicking. Figure (12) shows the force output vs. pressure input of the cylinders used.

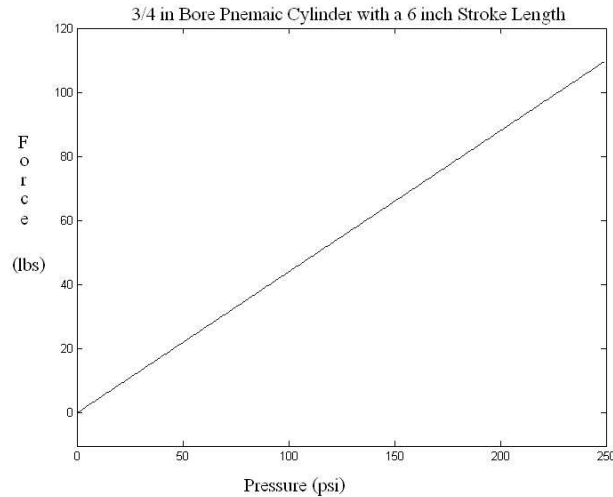

**Figure .13 Pressure vs. Force Plot of a 3/4 inch Bore Pneumatic Cylinder**

Two cylinders were used for several reasons. They allow a larger and heavier kicking plate to be used without sacrificing significant acceleration. It can also be wider along the ground plane producing a wider area to contact the ball. If one cylinder was used and attached to the middle of the kicking plate, the stress on the shaft would significantly increase when the ball contacts the edge of the kicking plate. Two cylinders also open the ability for directional kicking. Fire the right cylinder and the ball goes left. Fire the left, the ball goes right. Fire both and the ball goes straight.

#### 4.1 Air Reservoir Options

The air reservoir can be designed in two different ways. The reservoir can be large enough to hold enough kicks for the entire game or an onboard air compressor can refill a smaller reservoir. If the robot has enough room to house a larger tank, not having an air compressor allows the overall system to be simpler. We used a one gallon tank, which provides a sufficient number of kicks as seen in figure (13). We have an onboard compressor which turns on after 15 kicks and shuts off when the tank pressure reaches 150 psi. The compressor is controlled by a *PONTECH* microcontroller connected to the laptop's serial port. The controller along with a custom PCB can turn the air compressor on and off. It also monitors a mechanical pressure switch that opens at 150 psi. When the controller detects that the switch has closed, the compressor is turned off. As a result, the operation of the compressor is completely automated.

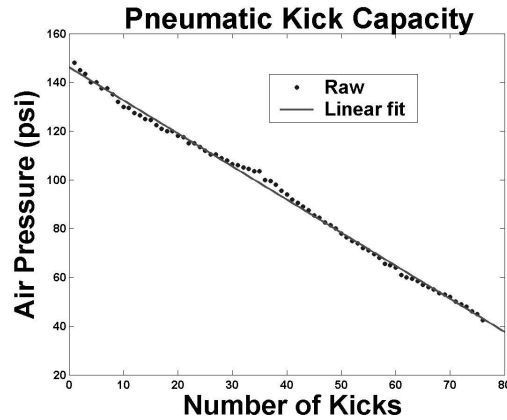

Figure 14. Number of Kicks v. Reservoir Pressure

#### 4.2 Velocity Test Results

The cylinders accelerate the ball to a max velocity of approximately 3.5 m/s, which is sufficient for a two on two game of Segway soccer. The velocity can increase to 4.5 m/s if the Segway RMP is moving at the ball when it kicks it. The theoretically predicted top speed for a stationary kick is approximately 4.3 m/s. The loss in velocity is due to the efficiency of the pneumatic cylinders, an imperfect impact with the ball, and ground friction. An experiment was setup using one of the cylinders, a small kicking plate, and a golf ball. The velocity of the golf ball was measured on a cement floor. This experiment was designed to significantly lower the effects of impact and friction losses. Through these tests, it was determined that the pneumatic cylinder alone had an efficiency of 75%. These losses are due to several factors including cylinder friction, exiting air resistance, and flow rate limitations. Impact losses and ground friction account for an additional 2% loss. The theoretical and experimental kick speed versus cylinder pressure plot is shown in figure (14). Furthermore experiments were conducted measuring the speed of the ball when the Segway RMP played back a kick motion in which it swung its base forward and simultaneously kicked. These results are seen in figure (15).

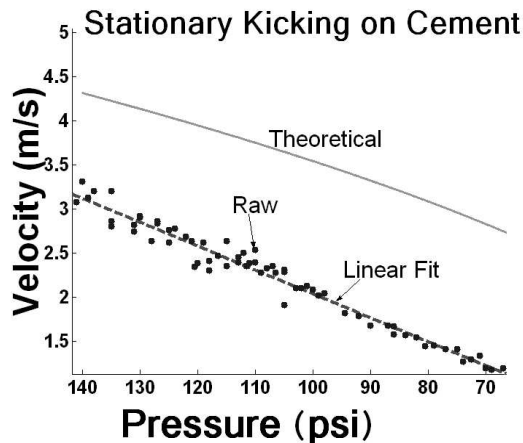

Figure 15. Experimental and Theoretical Pressure v. Kick Velocity

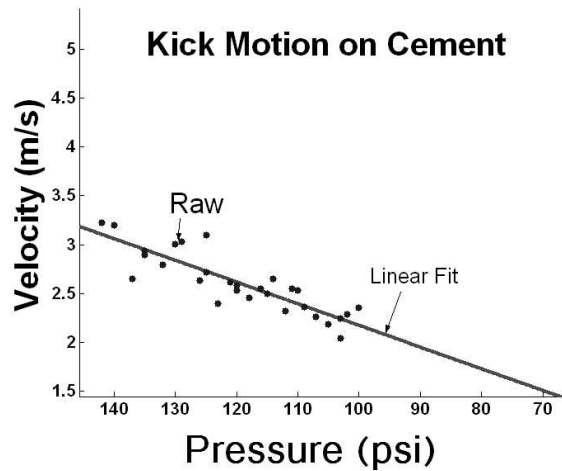

Figure 16. Pressure v. Kick Motion Velocity

### 4.3 Accuracy

The kick is sufficiently accurate as seen by the distribution in figure (16). The mean is 122 mm and the standard deviation is 175 mm. The mean error can be mostly accounted for by experimental error in lining up the kick. In practice, this mean and variance will be modified by the robots ability to position itself next to the ball.

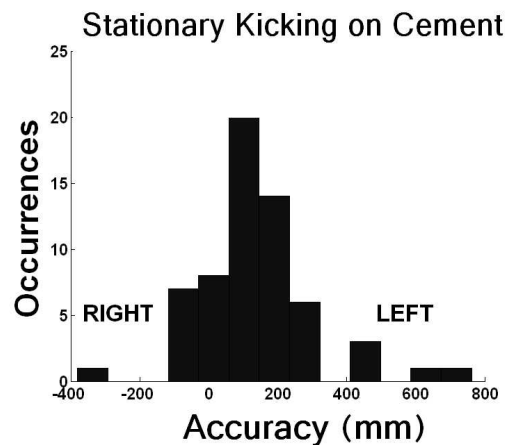

Figure 17. Histogram of Stationary Kicking on a Cement Surface

## 5 Conclusions

We have identified the challenges behind placing humans and robots on the same physical level utilizing the Segway platform. We have also established a scientific basis on which to choose a ball manipulation/kicking system for any size robot soccer player and have described the other mechanical systems necessary to make a Segway RMP physically capable of playing Segway Soccer along with humans. With our analysis, we have accurately implemented a pneumatic ball manipulation system, which robustly kicks the ball fast enough and with enough accuracy to make passing and goal scoring possible.



Our future work will focus on further developing the concept of Segway Soccer and on additional mechanisms to increase the soccer playing abilities of the Segway, such as recovering the Segway from a fallen state.

## Aknowedgements

Thank you to Mike Sokolsky, Fay Shaw, and David Rozner for their help in the construction of the mechanical devices. Finally, I would like to thank the funding sources, who supported and guided this research and development to address this specific problem.

## References

1. S. Behnke et. al., "Using Hierarchical Dynamical Systems to Control Reactive Behavior." *RoboCup-99:Robot Soccer World Cup III*. Berlin: Springer, 2000, p.189
2. M. Ferraresso et. al., "Collaborative Emergent Actions Between Real Soccer Robots." *RoboCup-2000:Robot Soccer World Cup IV*. Berlin: Springer, 2001, p.297
3. Ng Beng Kiat et. al., "LuckyStar II-Team Description Paper." *RoboCup-2000:Robot Soccer World Cup IV*. Berlin: Springer, 2001, p.543
4. G. Wyeth et. al., "UQ RoboRoos: Achieving Power and Agility in a Small Size Robot." *RoboCup-2001:Robot Soccer World Cup V*. Berlin: Springer, 2002, p.605
5. R. Cassinis et. al., "Design for a Robocup Goalkeeper." *RoboCup-99:Robot Soccer World Cup III*. Berlin: Springer, 2000, p.255
6. A. Bredenfeld et. al., "GMD-Robotst." *RoboCup-2001:Robot Soccer World Cup V*. Berlin: Springer, 2002, pp. 648-9
7. M. Asada et. al. "An overview of RoboCup-2002 Fukuoka/Busan". *AI Magazine*, 24(2): pages 21-40, Spring 2003
8. M. Nicolescu, M. J Mataric, "Learning and Interacting in Human-Robot Domains", Special Issue of IEEE Transactions on Systems, Man, and Cybernetics, Part A: Systems and Humans , Vol. 31, No. 5, pages 419-430, C. C. White and K. Dautenhahn (Eds.), 2001
9. M.B. Dias and A. Stentz. "Opportunistic Optimization for Market-Based Multirobot Control". Proceedings of the IEEE/RSJ International Conference on Intelligent Robots and Systems IROS 2002, 2002
10. M. Ferraresso, et al., "Collaborative Emergent Actions Between Real Soccer Robots." *RoboCup-2000:Robot Soccer World Cup IV*. Berlin: Springer, 2001, pp.297-300
11. N. Kiat, Q. Ming, T. Hock, Y. Yee, and S. Yoh, "LuckyStar II-Team Description Paper." *RoboCup-2000:Robot Soccer World Cup IV*. Berlin: Springer, 2001, pp. 543-546
12. Maxon Motors, "F 2260, Graphite Brushes, 80 Watt, No.880," <http://www.mpm.maxonmotor.com>] P. 95
13. Solenoid City, "Push Type Tubular Solenoid, Series S-70-300-H," [<http://www.solenoidcity.com>]