

**Data Communications at Carnegie-Mellon University***John Leong**Computation Center  
Carnegie-Mellon University**412-578-6722***July 24, 1985****Background**

CMU is a small private university with roughly 500 faculty, 4000 undergraduate and 2000 graduate students. It is one of the top research universities in the country, particularly in the field of Computer Science and Robotics. Computing plays a significant role on the campus - from the traditional academic and research computing to administrative support functions such as document preparation, spreadsheet and database applications. Because of the large computer user population on campus, a very effective and large electronic mail system is in place providing service to most of the faculty, staff and graduate student community. Electronic bulletin boards are also widely used.

Within the past 5 years, the computing environment on campus has been undergoing major evolution from the central data center model to one of distributed processing. Until the late 70's, with the exception of the Computer Science department, almost all departments relied on the computing resources provided by the Computation Center. Since then, with the decreasing cost of computing hardware, individual departments started acquiring their own machines. The pace of the distribution of computing power increased substantially with the introduction of high powered work stations and personal computers. Currently, there are over 150 DEC VAX 750/780 computers on campus together with approximately 200

SUN's, 200 ICL Perq's, 50 DEC Pro 350's, 50 HP9836's, numerous DEC PDP-11's and miscellaneous work stations such as Xerox Altos, and Symbolics's LISP machines. The 6 DEC-20's, 5 VAX's and a recently acquired IBM 3083 operated by the Computation Center represent only a relatively small percentage of the computing resource. In addition to the above, there are some 1500 IBM PC's and 500 Apple Macintoshes around the campus.

While this distribution of computing has brought advantages, it also threatens to fragment the campus. Unless steps are taken to ensure that all, or at least most of those heterogeneous systems can cooperate together in some way, the campus wide mail system and the ability for people to easily exchange information will be jeopardized. Our approach to these problems is to provide comprehensive networking capabilities to all parts of the campus and to provide a distributed filing system potentially accessible by all machines. A comprehensive networking capability addresses not only the issue of physical connectivity but all layers of protocols. One must be able to carry out at least file transfer, mail and terminal emulation among machines in the network.

This paper will only examine the networking issue. The distributed filing system will not be dealt with.

The paper is organised as follows : Part 1 part deals with the existing networking situation on campus. It describes the diverse and powerful computing resources CMU has acquired over the years.

Part 2 addresses the new developments and the ambitious undertaking of completely rewiring the campus. It is one of the largest projects of its kind in the world.

## Part 1 : The current networks

### The fibre Optic plant

The backbone network of the campus is a set of 144 fibre optic cables installed in 1982. This star shaped network represents our first major venture into the fibre technology. The network radiates from the University Computing Center to most of the academic buildings (see Fig. 1). A second phase installation will be carried out in the near future to provide connection to buildings not reached by the current cable plant and to provide additional capacity where required.

The fibre optics in use are the 50/125 micron variety. The actual inter-building cable contains a ribbon of 12 fibres. The ribbon is fanned out into individual cables at a distribution panel. Optionally, it can be spliced into another ribbon for continuation into another building (see Fig. 2). While the distribution panel provides configuration flexibility, the connectors and splices are a significant source of light (flux) loss.

The fibre optic cable plant installation was first class. The flux loss has been kept to a minimum by good splicing and connector installation. However, documentation left a lot to be desired. For the second phase installation, we will insist on comprehensive documentation detailing each cable run, location of all splices, initial patch panel configuration and measured flux loss for each fibre.

We have reservations about the choice of the 50/125 micron fibre. While it was the "standard" cable for Bell at that time, the standard has since moved to 62.5 micron. Furthermore, most of the local area networking equipment manufacturers have opted for the 100 micron fibre. This has caused a lot of problems. When one connects a 50 micron fibre to a 100 micron source, only 25% of the light gets into the cable. This 75% light loss at launch makes a number of devices inoperable. The 100 micron

Fig 1

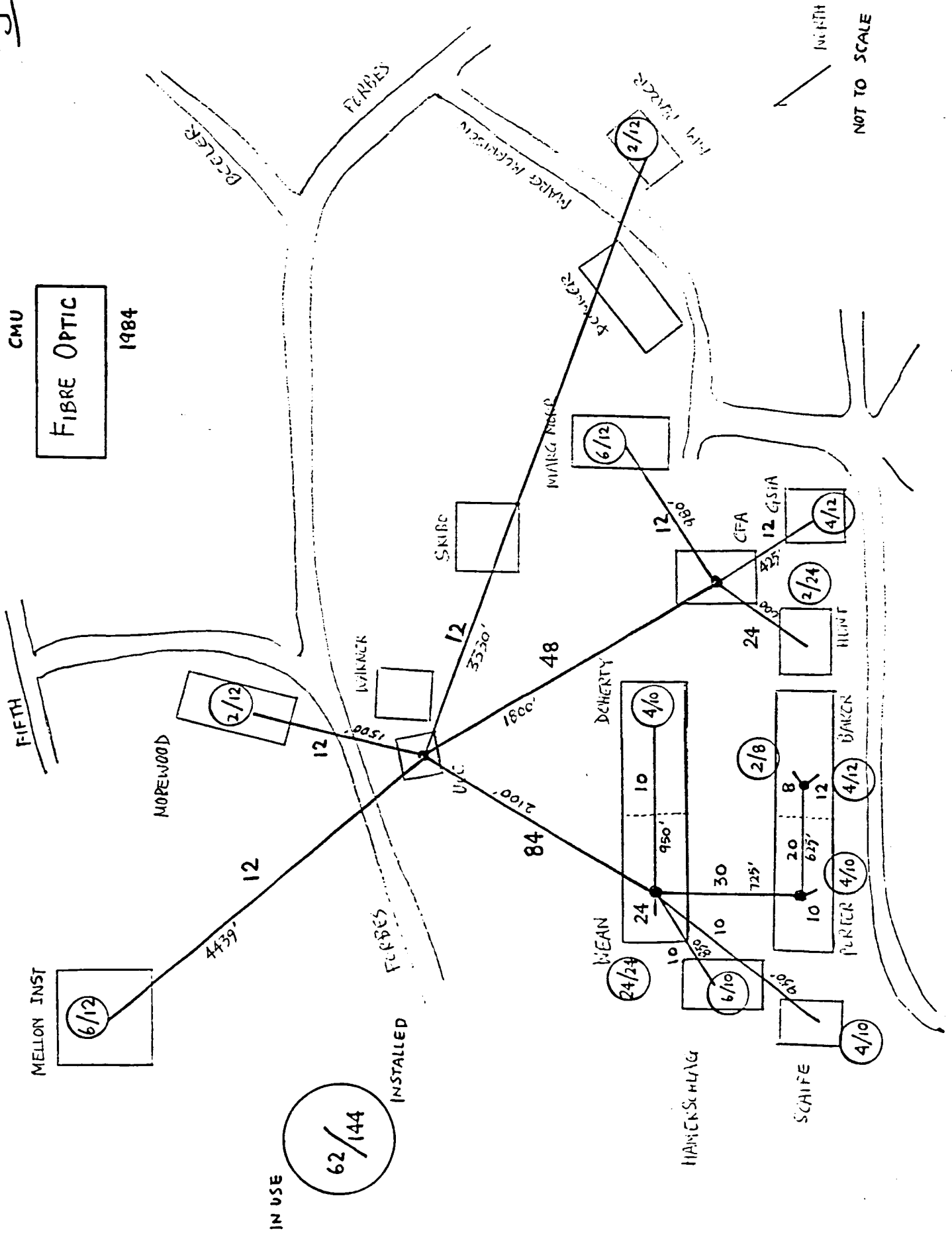

FIBRE OPTIC  
50/125 GRADED INDEX CABLE

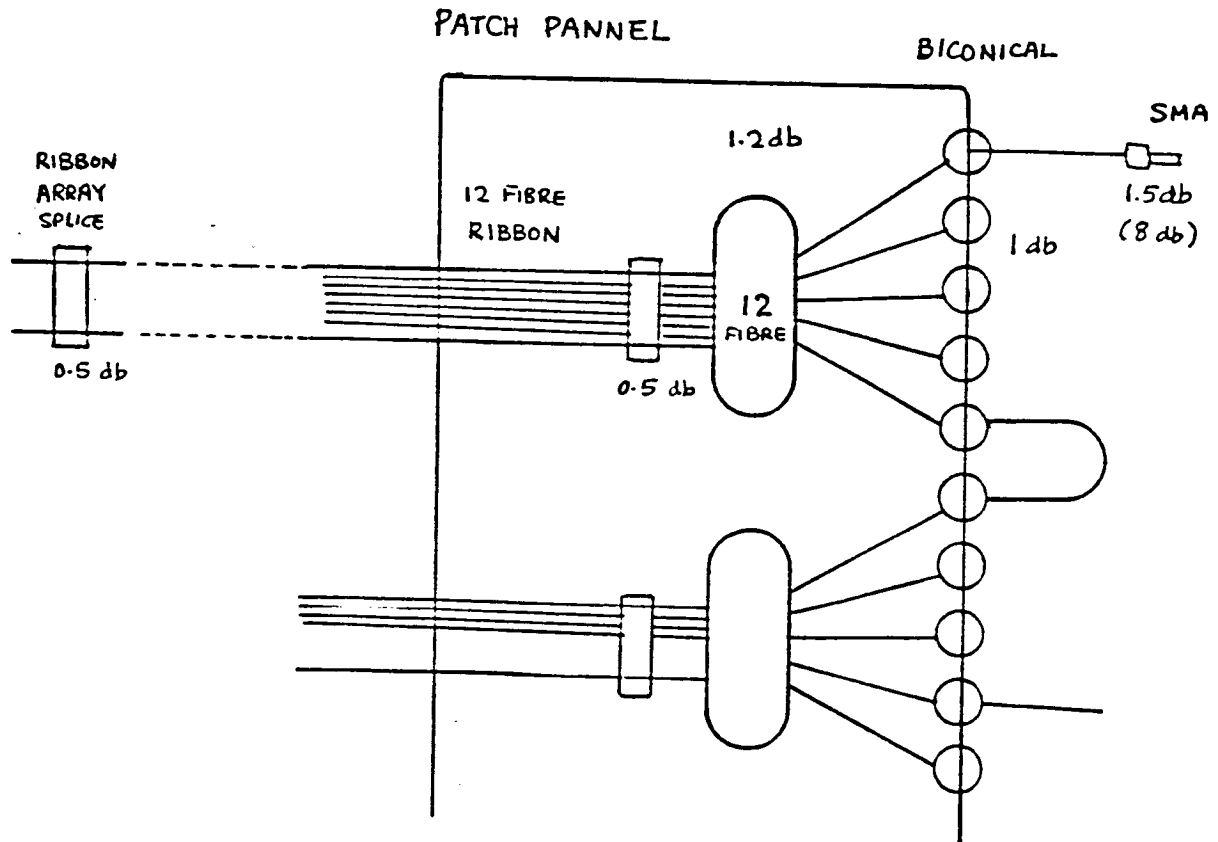

Fig 2

fibre is a better choice for local area networking environment. While its attenuation-over-distance characteristic is not as good as the 50 micron fibre, the connector loss is lower. For a telephony company, which typically uses fibre cables for long distance T4 trunking with few, if any, connectors between repeaters, 50 micron is a good choice. In a LAN environment, distance is not a big issue. Multiple connection points are desirable for re-configuration flexibility. Together, these make the 100 micron fibre a better choice. We will most likely be putting down some 100 micron cable for our second phase fibre installation.

Currently, the fibre optic cable plant is used mainly for the serial line network. While the fibre multiplexers in use hardly exploit the gigabit capacity of the medium, it is a cost effective application for this moment. We are looking forward to higher capability equipment or cascading of muxes to achieve better utilization of the fibre resource. The cable plant is also being used increasingly for the inter-building connection of local area networks such as Ethernet and ProNet at 10 M bps and DECNET at 1 M bps.

### **Serial line network**

Over the past 6 years, CMU has built up a sizable serial line network for the support of asynchronous terminals at 9.6K bps. Initially, Timeplex muxes were used to carry data from the remote locations over finer grade twisted pairs to one of 3 Micom-600 data switchers. This configuration has been completely changed. For the past year, we have replaced almost all the Timeplex muxes with Canoga fibre muxes. The use of fibre instead of twisted pairs for inter-building trunking has resulted in much lower transmission error rates. We are very pleased with the new arrangement.

The three data switchers have an aggregate capacity for approximately 2400 lines (terminal connections) and 1200 ports (computer connections). At the last count, approximately 2000 lines and 1000 ports were in use. Two of the switchers are located in the Computation Center while the

third is in another building. They are interconnected by T1 links. Currently, most of the lines are used to serve directly connected serial lines on the campus. A relatively small portion of the lines are allocated to support dial ups. This scenario will likely be changed in the future. Gradually, terminals are being replaced by PC's or workstations. They will likely to be connected directly onto the campus LAN. The Micom lines thus freed up will be used to increase support for dial up from homes.

While the serial line network and the Micom are operated by the Computation Center, services are provided for the connections of terminals with hosts operated by various departments and distributed all over the campus.

An interesting development in the serial line communication arena is high speed (9.6K) services from off campus locations. Most faculty and students who are not living on the campus are covered by 3 nearby Bell central offices. Experiments have been carried out with Bell Atlantic to put low cost voice/data mux in the existing subscriber loop. In the CO, the data will be de-muxed and feed directly back to campus using T1 links. The voice part of the signal will be connected to the peripheral shelf of the voice switch as usual (see Fig. 3). The use of data can be done totally in parallel and in no way affect the basic voice service. Similar experiments have been conducted by Bell Atlantics with Virginia Polytechnic Insitute (VPI). They are at a more advanced state than us. They have apparantly experienced a lot of problems with their local loops. However, once those problems were resolved, the service worked fine. The pricing for such service has as yet to be worked out. We, and VPI, expect that it will be "very reasonable" from the point of view of a subscriber who is not subsidized.

For PC's deployed over the asynchronous serial network, the main communication package in use is Kermit. It is a package from Columbia University. In general, it works well and supports both terminal emulation as well as file transfer. A file server module for this protocol is available for all our main operating systems (VAX VMS, UNIX 4.2, TOPS-20 and IBM VM). A version of this program is also available for use with the

FIG. 3

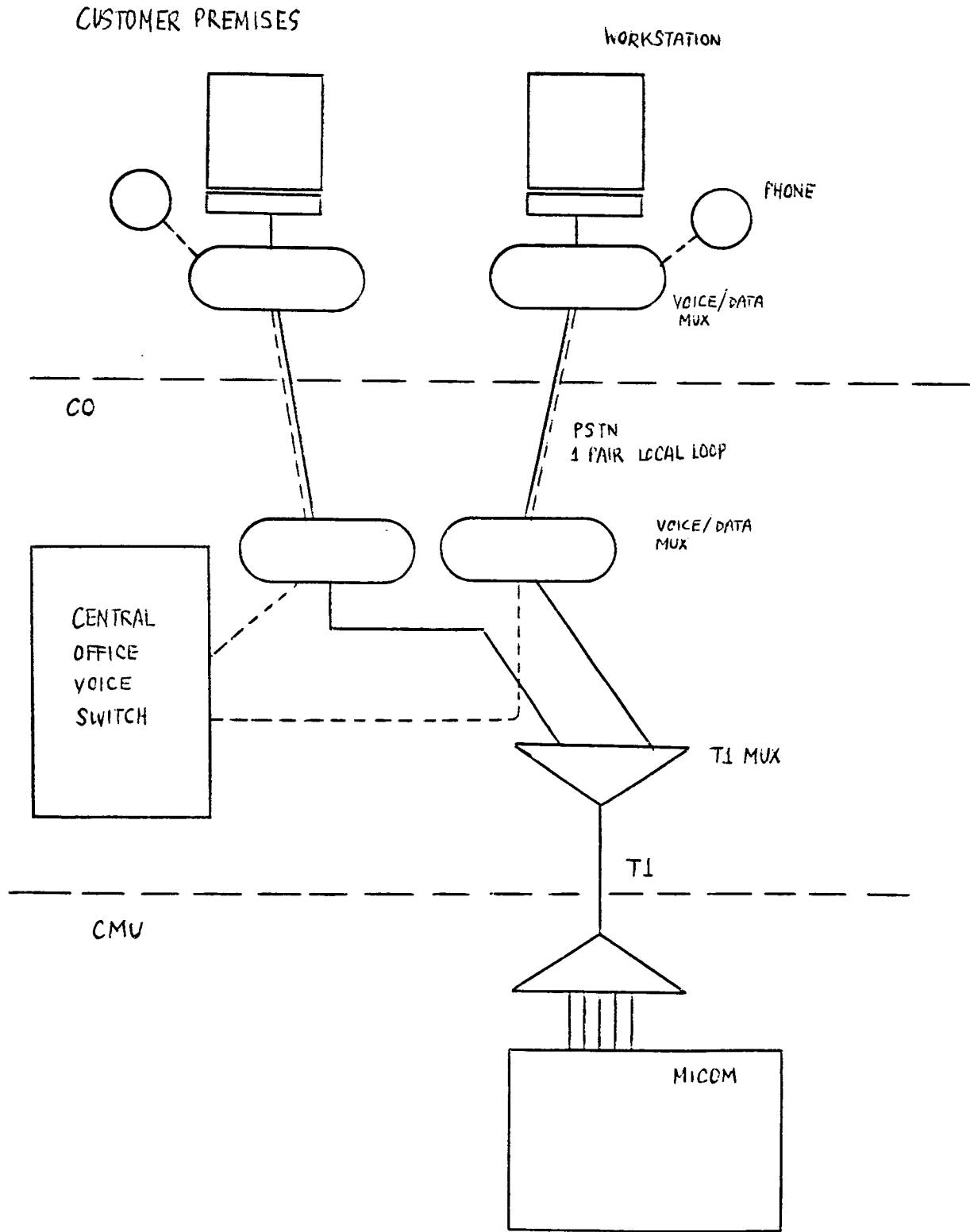



Apple Macintosh. I have some reservations, however, with the protocol used. Unlike synchronous protocol with distinctive frame start and end sequence such as HDLC or SDLC, the asynchronous protocol inhibits the use of DMA operation for in-bound traffic by the host. In the era when such traffic was generated by humans using dumb terminals, it was not a problem. In the PC world, the interrupt load can get intense for the server, particularly during a PC to server file transfer. As a result, for some machines, a restriction has been imposed to limit in-bound traffic to 300 bauds. This situation will continue until we start using synchronous protocols inductive to some hardware assistance from communication chips such as the Zilog SCC.

### **General Purpose LAN's**

CMU has been using Ethernet for over 5 years. We started with the experimental 3 megabit Ethernet. Two years ago, different departments started installing private 10 megabit Ethernets. Unlike the university administrated serial network, Ethernet installations were done on a departmental basis with little or no central planning. Currently, there are 14 separate networks with over 20 segments on the campus. More than 600 machines for all types are attached to these Ethernets.

Another major type of LAN in use is a 10M bps token ring from Proteon called ProNet. It operates over shielded twisted pairs and fibre optic cables. Our main interest in this networking technology is that it can run on the IBM cabling system and will give us experience in token ring operation. While this network is similar in concept to the token ring proposed by IBM to the IEEE 802.5 committee, it is a very different animal. Indeed, besides the different in frame format, the simple fact that one is a 10 M bps ring while the other is a 4 Mbps ring means stations with interfaces for the different net cannot co-exist on the same ring. There are 5 ProNet's connecting all the computation center's machines as well as a number of IBM PC clusters.

## LAN Applications

The main inter-machine traffic between the VAX 750/780 class of machines are user initiated file transfers, mail, and, to a lesser extent, terminal emulation for users with accounts on more than one machine. Since some of the file transfer operations can be quite large (e.g.: transfer of a whole multi-level directory), the availability of a high speed LAN is very desirable.

In the case of the PC's, there are two main usage profiles. Some machines are grouped together in the cluster configuration. For Ethernet, the most popular package in use is the 3COM EtherSeries. For ProNet, we use the Novell Netware package. Both packages support file, mail and printer servers. In the other usage profile, the typical mode of operation is : download file from host for local editing or other tasks, then up load result for archive or further processing. Further processing on the host is typically done under user control with the PC running in terminal emulation mode. The most popular package for this profile is the PCIP package from MIT. The package will operate over both Ethernet and ProNet. Since file transfer is a main application for either profile, high speed LAN is again a plus.

The most intensive user of the network belongs to the class of machines we shall refer to as high function or advanced work stations. Typically, they consist of powerful processors with megabytes of RAM. Applications running on those machines tend to require a lot of disc space. Usually, this is supplied by a disc or file server. Besides offering the economy of scale, file servers offer a convenient means of code and data version control as well as the potential added benefit of professional operation support in areas such as archiving and backup. The coupling between such high function work stations to the file servers can range from loose - operator invoked file transfer, to very tight - system initiated. The extreme sample of the latter case is the discless workstation where even paging has to occur across the net. It is interesting to note that we have one Ethernet supporting 15 discless SUN's which relies on network disc servers, another 20 SUN's with relatively small discs which relies on remote file servers and 2

VAX's - all running the heavily disc access dependent UNIX 4.2 operating system. While the net has been kept very busy almost all the time, the performance of the network has never been identified as a problem.

The relatively network intensive, high function workstation is the greatest growth area within CMU. Currently, as mentioned earlier, we have 200 SUN's, 200 Perq's, a number of Altos and a number of miscellaneous machines. This summer, we will be taking delivery of over 200 Micro VAX II and a similar number of another workstation of the same class this fall. The intent is to provide every student and faculty with easy access to such workstations by the end of 1986 and as the cost of the equipment goes down, every one should have his own machine.

Our strategy to bring about integration and order into the distribution of computing depends on a distributed filing system currently under test. This system will enable machines all over the campus to share one logically "central" giant filing system. In order to support this file store and the large scale across the campus deployment of workstations a fully interconnected, all reaching network must be in place on the campus. This objective is to be tackled in two stages. The first step is to fully interconnect all existing high speed LAN's on the campus and ensure that most, if not all the heterogenous machines attached have the capability to communicate meaningfully with one another. The second phase is to provide every part of the campus with a planned, comprehensive and coherent communication utility, in the same manner as power of phone outlets. Today, step 1 is more or less completed and step 2 is underway.

## **Part 2 : Migration into the Future**

### **Physical Interconnection of Existing LAN's**

Fibre optic cables are used for inter building connection of the LAN's.

The use of fibre optic as a loop of the ProNet token ring is quite straight forward and relatively inexpensive. The same cannot be said for Ethernet. First of all, we had to be careful with the distance limitation introduced by the collision detect algorithm. Then we had to make the equipment work with our 50 micron cable plant. Both Ungermann-Bass and Digital Equipment had produced remote repeaters for 100 micron cable operation. Because of the 75% coupling loss, the DEC repeater can only be used on very few fibre runs even with careful connector re-installation. The Ungerman-Bass repeater fares better since it has a higher flux budget. However, it is relatively expensive. We have examined some of the fibre optic ethernet offerings. They are essentially star shaped Ethernets with pairs of fibre optic cables running into a light 'mixing' hub. Again, we have found flux budget to be a problem since the flux loss at the hub can be quite significant. On the whole, the most cost effective compromise we have come up with for our particular configuration is a fibre optic drop cable kit marketed by American Photonics. The kit is engineered for 50 micron fibre and can also be used over 100 micron cable.

### **Logical Interconnection of LAN's**

The objective for the LAN interconnection is not just to achieve physical connectivity but to provide capability for machines to "meaningfully" communicate with one another. After careful examination, it was decided that the main services required by heterogenous machines attached to heterogenous networks using different protocols are the ability to send mail, carry out file transfer and provide terminal emulation capability. The main problem is the incompatible protocols. One of two things can

be done : all machines have to have the capability to handle all the different protocol types on campus or all machine will have the capability to handle a "standard" protocol besides the native protocol it uses. The second approach was chosen since it required less work.

### **Standard Protocol**

What protocol set should be used as standard? The selection criteria is that the protocol set must be available on a wide range of current and future machines, i.e.: the protocol must be backed by some powerful organization. Three protocol sets were short listed. They were SNA, CCITT/ISO and DARPA protocols. The first set is backed by IBM and every manufacturers would like to provide the capability to connect their machines to the IBM mainframes. This protocol set was dismissed as it is rather complex and we have no current user at CMU. The CCITT/ISO protocols are backed by the powerful PTT's particularly those in Europe and Japan. Again, it was dismissed for the lack of user. More importantly, the application level protocols are still not yet well and fully defined (with the exception of Teletex and X400 on message handling from CCITT and a draft low function File Transfer Protocol from ISO). The DARPA protocol is backed by the Department of Defense. Furthermore, it is the most popular protocol in the research and academic community. It is also the most widely used protocol on campus. Additionally, it is an integral part of UNIX 4.2 which is the strategic operating system for our high function workstation development.

The other major protocol in use is DECNET. CMU has a sizable DECNET consisting of 6 DEC-20 running TOPS-20, approximately 15 VAX 750/780's, 50 Pro-350 and a number of Micro VAX I and II's running VMS. The CMU DECNET is also part of a larger DECNET interconnecting VAX's and TOPS-20's in Columbia University and Case Western. The relatively heavy usage of this protocol does not really pose a problem since software packages are available to run on both systems such that they can handle both the DARPA protocols as well as its native DECNET protocols. Indeed we can find DARPA protocol packages either already available or under development for almost all machines on campus from

IBM PC to 4341 or 3083 running VM (compliments of MIT and University of Wisconsin, respectively).

## **Router**

After settling on a standard protocol, the connectivity issue was addressed. The baseline is that while we would like to logically connect the nets together, we would also like to avoid direct physical connections of networks. Physical connections of two Ethernets have the problem of allowing all packets in one net to appear on the other. This can pose both a security problem as well as summing the traffic of both nets. The approach we used was to inter connect with a "router". This is a PDP-11 based ISO level 3 (network layer) router developed by the Computer Science department. A lower cost 68000 based router implemented by the Electrical Engineering department is now being deployed. The number of networks a router can interconnect depends on the performance of the machine as well as the number of interface cards the hardware can support. Currently, the type of networks supported are Ethernet, ProNet, 56K and 9.6K synchronous point-to-point links, 9.6K asynchronous point-to-point link and AppleTalk.

The function of the router is relatively simple. It will dynamically build up a table of which machine lies on which network (interface) and will route packets addressed to it accordingly.

The following is a quick tour through the algorithm (see also Fig. 4):

In the DARPA world, each machine has an assigned IP address. It is a network level address. While the physical address of the machine may change depending on the interface board used, the IP address remains unchanged. In order for an IP machine (IP1) to send a packet to another IP machine (IP2), it must discover the physical address (HW2) of the recipient. If the sender does not already know the mapping, it will broadcasting an Address Resolution Request (ARP request). The ARP request essentially says "I am IP1 at HW1; Will IP2 please let me know your hardware address?". If IP2 is in the same net, it will hear the request and

Fig 4

1) IP1, HW1      Broadcast  
    IP2, ?      →



2)                      IP1, HW1  
    ←                      IP2, HW2  
                            HW1

1) IP1, HW1      Broadcast  
    IP2, ?      →

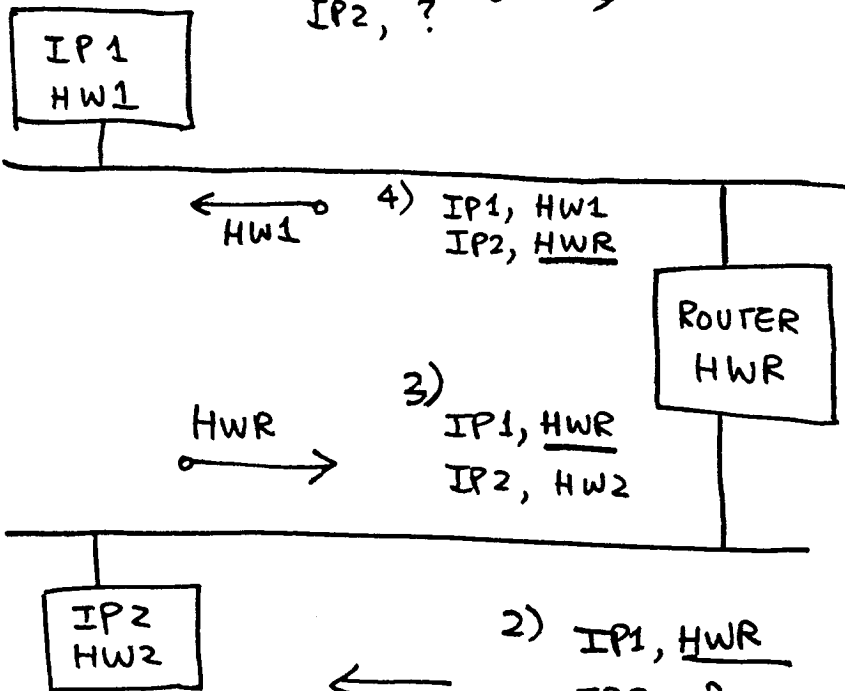

4) IP1, HW1      Broadcast  
    IP2, HWR      →  
    ←                      HW1

3)                      IP1, HWR  
    ←                      IP2, HW2  
                            HWR

2) IP1, HWR  
    ←                      IP2, ?  
                            Broadcast

will reply with its physical address in the form "Hello IP1 at HW1, I am IP2 at HW2" This method of discovering the logical to physical address mapping was a DARPA standard and is mainly for single LAN operation. We extended this for multi-LAN operation. In that case, when the router hears the ARP request broadcast, it will log the fact that IP1 has a hardware address of HW1 and then will relay the request to all connected nets as "IP1 at HWR, looking for IP2". Note that it is lying to the world that IP1 has the hardware address of the router, HWR. If IP2 resides on one of the connected nets, it will reply to the router, thinking that it is IP1. The router picks up the reply "Hello IP1 at HWR, I am IP2 at HW2", logs the mapping of IP2 to HW2 and relay the reply back to IP1. The reply again will be altered as "Hello IP1 at HW1, I am IP2 at HWR". This leads IP1 to believe that IP2 resides in the router. From then on, all message from IP1 to IP2 will be addressed to the router. The same will apply to traffic from IP2 to IP1. Note that the router will only need to examine and possibly relay packets addressed to it, either directly or through broadcast. It does not need to examine every packets in the networks.

The elegance of this approach is that it is simple. There are three shortcomings however. The first problem is that ARP request is relayed as a broadcast. Since broadcast has to be handled by every attached station in a net, this can become quite expensive for a large inter-connected set of nets. We have a modified version of the router under test which will heuristically change some of the ARP request to be relayed from broadcast to point-to-point transmission. The second problem is that our current algorithm does not allow loop in the topology. This means no redundant path. While it has not been a problem for us since the reliability of the 12 deployed routers has been very high, redundant paths are still desirable. This will be provided by the next version currently under development. With the availability of redundant paths, we will be addressing the issue of 'best' path as well as load sharing. The third problem with this scheme is that ARP is native only to the DARPA protocol set. Since all machines on campus will support DARPA protocol it is not a serious problem. However, it would be nice to enable 2 DECNET hosts on separate physical networks to communicate using native DECNET protocol. This is under study.



We have now 10 routers in deployment connecting all the LAN's together. On the last count, there were over 300 IP nodes on those interconnected networks (see Fig. 5).

We have examined alternative algorithms for the router. For the DARPA protocol sets, an alternative approach to the ARP relay is to divide the campus IP network into sub-nets. A field in the IP address will be used to denote the ID of the sub-net the machine is attached to. The routers will cooperate so that each one will know the best path to a given subnet. A machine wishing to transfer a packet to a destination on a different subnet will forward the packet to the router which will do the appropriate forwarding. While this approach requires IP address re-assignment whenever a machine is moved from one subnet to another, it does offer an interesting and potentially more general solution. This scheme is favoured by other universities such as MIT and Stanford.

Another network interconnection scheme we have examined is a link level (ISO layer 2) bridge. Vitalink produces such a product. A description of this unit can be found in the May 85 issue of Data Communications. Essentially, the bridge examines every packet and builds up information as to which station resides on which side of the box. We have some reservation about the performance since it has to handle and examine every packets on 2 connected networks whether they require forwarding or not. Unless the packet handling software path is very short, packets can be lost during substained heavy traffic periods. While the configuration which requires a \$20,000 box per network is suitable for connection of networks separated by long distances, it is not optimum for our network environment where one box should be able to interconnect 2 or more nets.

### **Current Network Developments**

In 1982, CMU, in cooperation with IBM, started a major distributed computing development. The objectives are to provide the campus with a sa-

# Logical Cable Map with Interesting Computers

by Rudy Nedved and Vince Fuller

May 1985

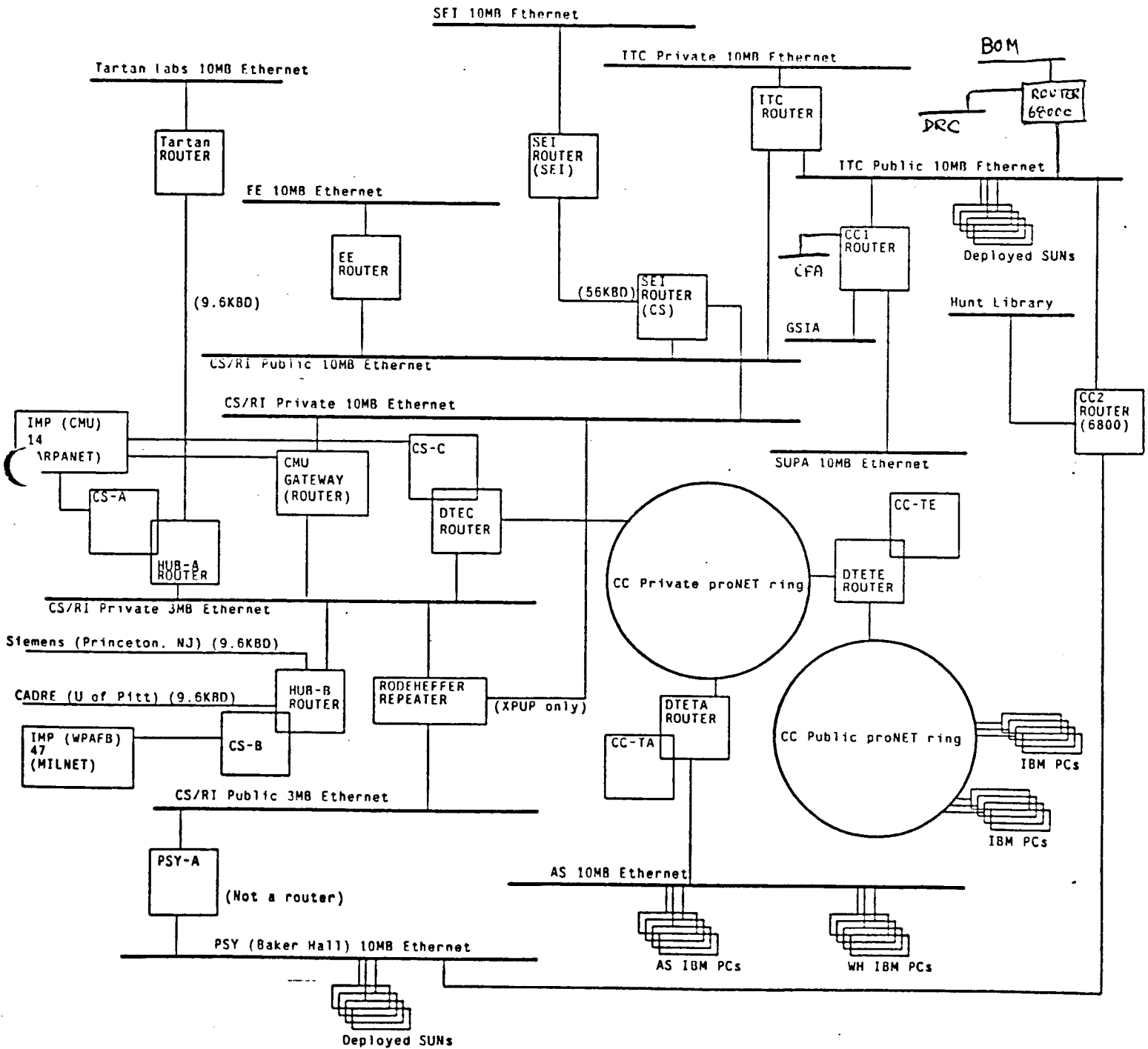

turating network utility of more than 7,000 nodes; design a high function 'scholar' work station suitable for mass deployment in the campus; develop a large scale distributed filing system to support such deployment.

A new organisation, the Information Technology Center, was formed to carry out the mandate. This group is funded by IBM for 5 years and is composed of CMU and IBM technical staffs.

### **The cable plant for the century and beyond**

In the area of networking, we have to examine both the physical cable plant as well as the actual networking technology. While the cable plant must be able to support the initial network technology to be used, over the next 20 years, the technology of today will likely become obsolete. However, the cable plant, however, will be around for decades. Furthermore, it will likely to be called upon to support multiple network types - concurrently. The new cable plant will therefore be considered more a communication utility than an ad-hoc network installation. Similar to power installation, the intent is to have at least one outlet per room, quite independent of whether they are used or not. The current estimation calls for over 10,000 outlets. Most of the complexity and cost of the cable design and installation will come from intra-building distribution.

One of the first candidates to come under examination was broadband CATV. It has the capability to support voice, video and data. After the customary debate over the issues, we have decided to concentrate our evaluation on more standard data communication network approaches. The main reasons against broadband are the current lack of cost effective high speed data support, high cost of broadband modem, lack of good definition for campus wide video applications and our lack of experience in broadband. We have also observed that maintenance of a 2 way broadband system with thousands of signal sources all over the network is quite a different kettle of fish from the traditional uni-directional, single source, commercial CATV environment. Although we have decided against using broadband type of cable plant for intra-building distribution, we have not

discounted broadband, particularly, video capability all together. We may decide to run digital, or even limited amount of analogue video over the fibre backbone when the need arises. On the topic of voice, while data network technology can be easily made to transport digitised voice, we have decided to leave voice to the domain of PABX. It is interesting to observe that a lot of effort has been expended by PABX manufacturers to provide telephony applications and features. The actual voice switching and, in particular, transmission has been taken for granted.

The main contenders for cabling topology were the bus or interconnected-star. While we have a lot of experience with the bus approach from our work with Ethernet, we would prefer the star configuration from the point of maintainability. In the case of bus topology, cable installation and expansion is relatively easy. The overall cabling cost will also likely be lower. However, since the equipment can be connected to the trunk at any point, when problems occur, one is left pondering where along the trunk the problem may have occurred. In the case of a star configuration, fault isolation and trouble shooting can normally be confined to the "wiring closet" locations. Over the life time of the cable plant, the relative ease of maintenance can easily offset the potential higher initial cost of interconnected-star approach. The decision to use the star topology also fits very well with the desire from the campus telephony group to re-wire the campus for phone. Since they share the same topology, both networks can be installed at the same time with little additional labor cost.

After settling on the star topology, we examined the type of cable to be used. The choice here were : co-axial cable, phone wire or shielded twisted pair. Coax cable was discounted when we decided not to use broadband for intra-building distribution. Since we have to install new cable anyway, we opt for the shielded twisted pairs instead of additional phone wires. In spite of its higher cost, the twisted pairs offers much better performance.

Next came the question of how many pairs. Most networks requires 2 pairs. These include ProNet, AppleTalk, AT&T's StarLAN and ISN. However, Ethernet requires 4 pairs for drop cable. This caused us a lot of problems since Ethernet is by far the most used network on the campus.

The problem was eventually resolved when we found a company called Astra Communications that made Ethernet for operation over two twisted pairs or fibres configured in as interconnected stars. The actual cable we decided to use is the IBM type 2 cable from their Cabling System catalogue. It contains 2 shielded twisted pairs for data as well as 4 phone pairs. This is very convenient since we are wiring for both voice and data. On the down side, the cable uses solid core conductor. It is stiffer and bulkier than comparable cable with multiple strand construction. It is interesting to note that the shield data twisted pair can be turned into a coax cable with a balun. This is the way IBM uses its cabling system to support 3270 type terminals. We will be investigating the possibility to turn the cable into 75 Ohm coax with the appropriate balun for broadband application.

In each building, there will be at least one wiring closet. Type 2 cable will be run from the wall outlet into the closet. The voice pair will be split out and connected to standard telephony punch block while the data pairs will be terminated in a rack mounted patch panel. A typical wiring closet will support a maximum of 150 to 200 outlets. If more outlets are to be supported by a single wiring closet, the cable bundling in area near the closet entrance can get quite severe and will require excessive amount of cable tray or other structures. For buildings with multiple wiring closets, one of them will be designated as the Main Wiring Closet (MWC) and one as Building Entrance Facility (BEF). For most buildings, these two are actually in the same room. The BEF serves as the connection points to other buildings for voice and data using fibre cables. All wiring closets in the building will have connections to the MWC. It serves as the inter wiring closet connection center (see Fig. 6). The cable used for connection between wiring closet and MWC will be the IBM type 1 cable which contains only the data twisted pairs. There will not be a 1:1 ratio of type 2 cables to type 1 cables since we are assuming some multiplexing electronics can be placed in the wiring closets. However, in the case of voice pairs, such multiplexing will be done, if at all, only at the BEF. Standard telephony multi-pair cables will be used to trunk the voice pairs between the closets and the BEF.

The size of the wiring project is huge. Approximately 50 buildings of vari-

FIG 6

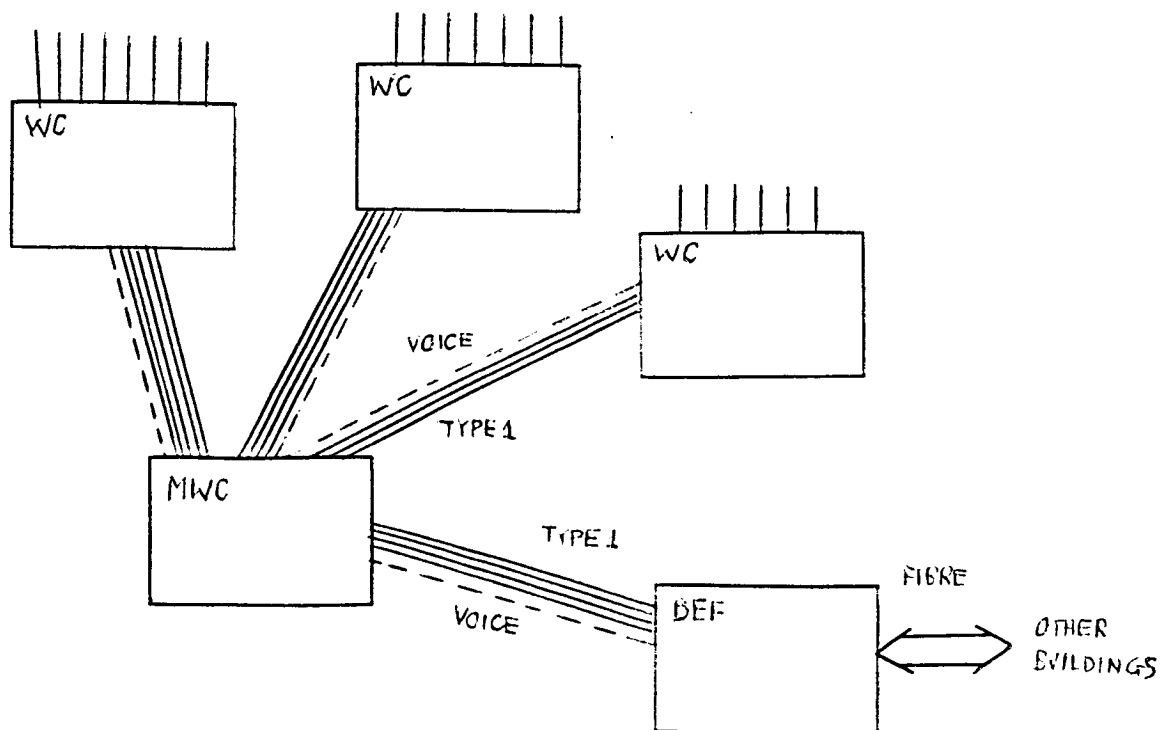
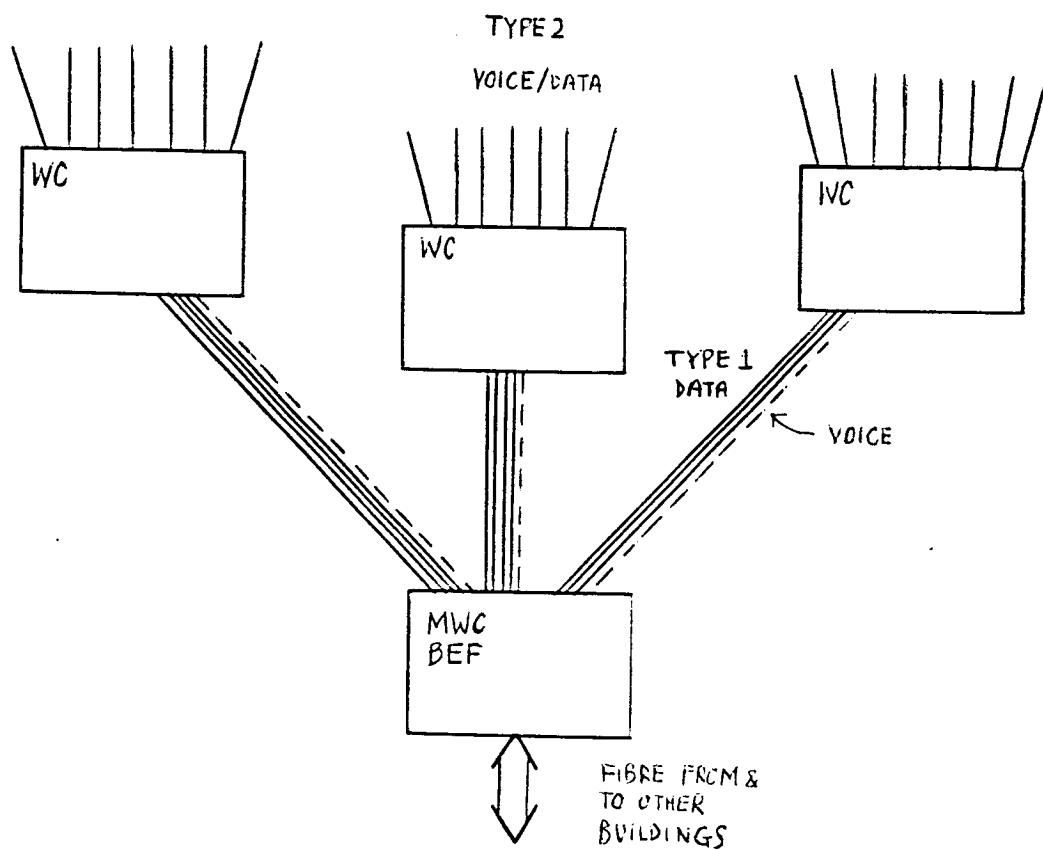

ous size, shape and vintages will be affected. More than 10,000 outlets will be installed. The current estimation cost of the project runs over \$7 million. Most of this will go into labour. The design of the cable plant is already underway. Installation will start by the end of July 1985 and completion is expected by end of 1986.

### **LAN Technologies**

The most prominent LAN technology in use today at CMU is Ethernet. We also have a significant amount of ProNet equipment deployed.

Our experience with Ethernet has been very positive. Ethernet is a relatively mature technology. It is an IEEE standard and has been adopted by a large number of computers and electronics equipment manufacturers.

Ethernet has established itself strongly in the scientific and engineering fields. VLSI implementations at reasonable cost are available from Intel, AMD, Fujitsu and SEEQ. As mentioned previously, the disadvantage of the network is its potential difficulties in maintenance and problem isolation - especially for very large scale installation. Proper network design and installation will help.

We are reasonably happy with ProNet. However, it is not a standard and Proteon is the sole supplier of that particular networking technology. This can be a problem since Proteon has to manufacture boards for the various manufacturers' equipment and deliver software for them. All this can stretch a company's resources tremendously. This problem also applies to the various "proprietary" networks such as the AT&T's ISN or Wang's WangNet. We cannot see companies, even one with as deep a pocket as AT&T, producing interfaces for equipment developed by every obscure company. However, it will not be difficult for those obscure companies to produce the more popular and public domain interfaces for their own machines. We see proprietary networks as a means by which companies can tie users to a particular product line. We have no reservation with limited deployment experimentation with these types of networks, but they

will not be appropriate for large scale campus wide deployment.

While we are not too excited about AT&T's "proprietary" approach to ISN, we are interested in their relatively new public domain StarLAN using the Intel 82588 chips. However, there is not a lot of equipment in the market yet with that interface.

After dismissing broadband network, we have also diverted our attention away from the token bus technology. Incidentally, we think token bus is the most appropriate technology for broadband. While no VLSI implementation is available yet for the IEEE 802.4 algorithm, one can get TTL boxes from Concord Data Systems at a rather high price. An interesting interim approach is to use Datapoint's well proven ARCNET chip from SMC at a very low cost. While on the topic of broadband, we think that CSMA/CD is not a particularly good approach for this type of network since collision detection is not easy to do. Furthermore, because of the CD algorithm, the range of the network is substantially limited in comparison to the standard CATV system.

We have evaluated carefully the IEEE 802.5 or the "IBM" token ring. We were very impressed by the specification. It is one of the few networks designed with strong emphasis on error detection and maintenance. It is manageable. When will it appear and will it be successful? Rumors abound that it will make its entry this year. We will have to see. We think it has good potential to succeed, particularly in the commercial world, providing :

(1) IBM demonstrates that it is their corporate strategic network and not "yet another PC net". They can show this by providing or at least announcing interfaces for their mini's such as the System/36 and 38 as well as their main frames such as the 43XX and the 308X.

(2) VLSI implementation of this network becomes available in the public domain soon after the network introduction. This will enable communication and computer vendors to produce interfaces for the network.



The main challenge to the token ring in the commercial market comes from PABX. Its big potential advantage is the avoidance of costly cable plant installation. However, it currently has limited data capability. This will be increased in the future. However, the inherent point-to-point nature of the PABX-based network potentially poses problems for distributed system design. There are significant advantages to bus or ring type of approaches where a station can communicate with a number of servers without having to incur the penalty of call set up or risk blocking. Typical call set up time of a PABX ranges in the order of hundreds of milliseconds. Furthermore, unless the PABX manufacturers provide public domain interfaces for connection into a host's bus, the host has to provide a large number of serial line ports in order to support a large number of users. This can be a problem. From our serial line experience, we have noticed that the utilization of port connections is typically very inefficient. However, while we have opted for a dedicated data network, data feature will not be ignored in our selection for a PABX.

On the whole, we see that Ethernet will continue to be our major networking technology for a while. We will be most interested in investigating the "IBM" token ring technology. Pronet will continue to be used until they discontinue the product. Proteon stated that they will change their net to the 802.5 standard when that becomes available. AppleTalk will also be a significant network particularly among the students since they have acquired a lot of Macintoshes. All these networks can be supported by the cable plant we are installing.

While we have not yet established the administration plan for the cable plant in detail, it will likely work as follows. The wiring closet will serve as a data communication bazaar supporting a limited number of approved networking technologies (see Fig. 7). Users will apply to the data communication office to have their outlet "activated". After registration, the cable will be connected to the requested networking equipment in the wiring closet. The outlet will then be clearly labelled as to what network type it has been activated for. People illegally tampering with the outlets will be dealt with in the same manner as people caught tampering with phone or power outlets. While we don't expect any problems in the academic build-

FIG 7

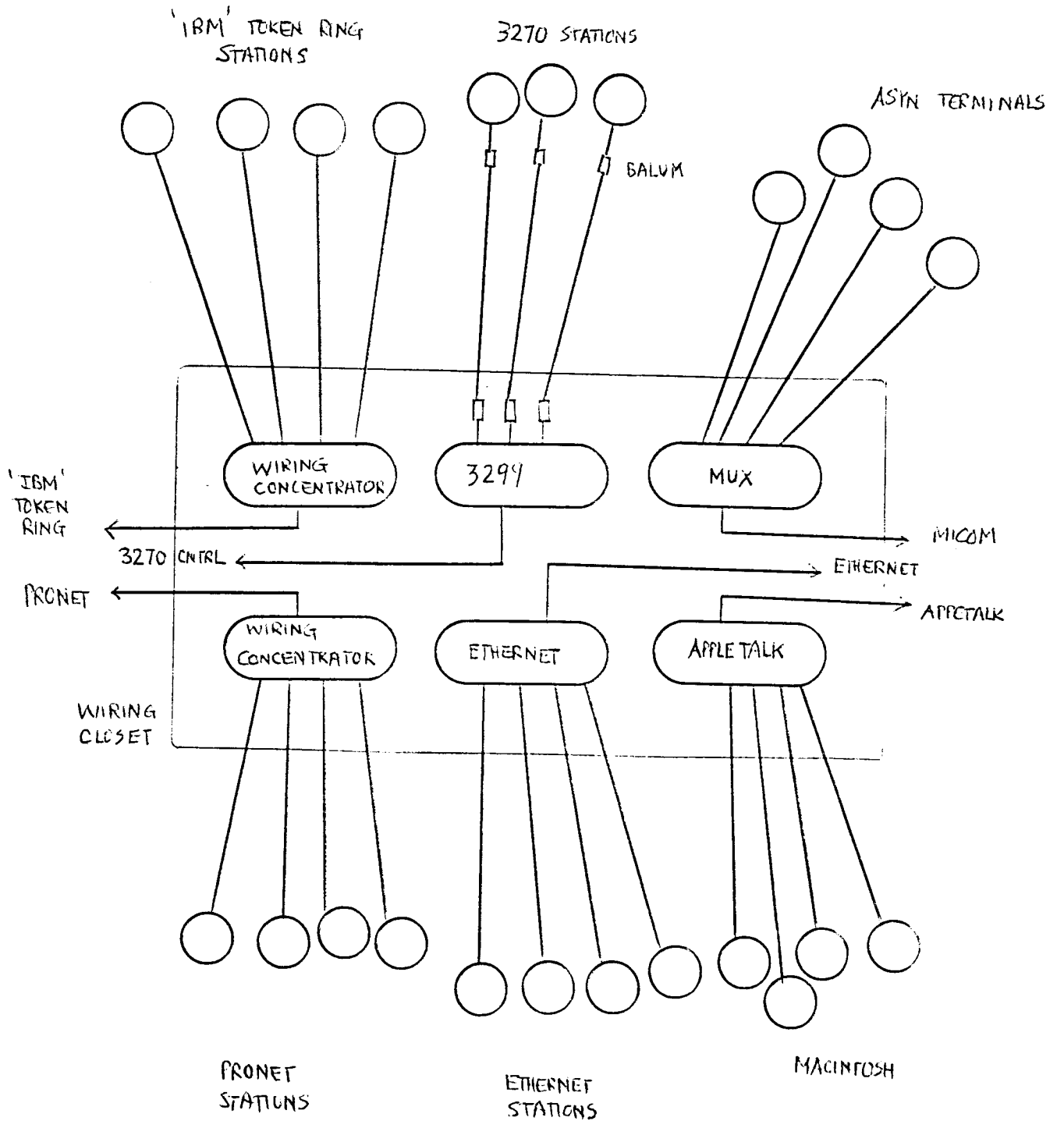

ings, we are a bit nervous about student residences and frat houses. Time will tell.

In conclusion, CMU's internal communication service is undergoing a very interesting and important transformation. If all goes well by 1987, we will have one of the most comprehensive communication structures in place.